

Introduction to Electronics

Instructor: Morgan Redfield
2009 Nov 15
2-4 PM

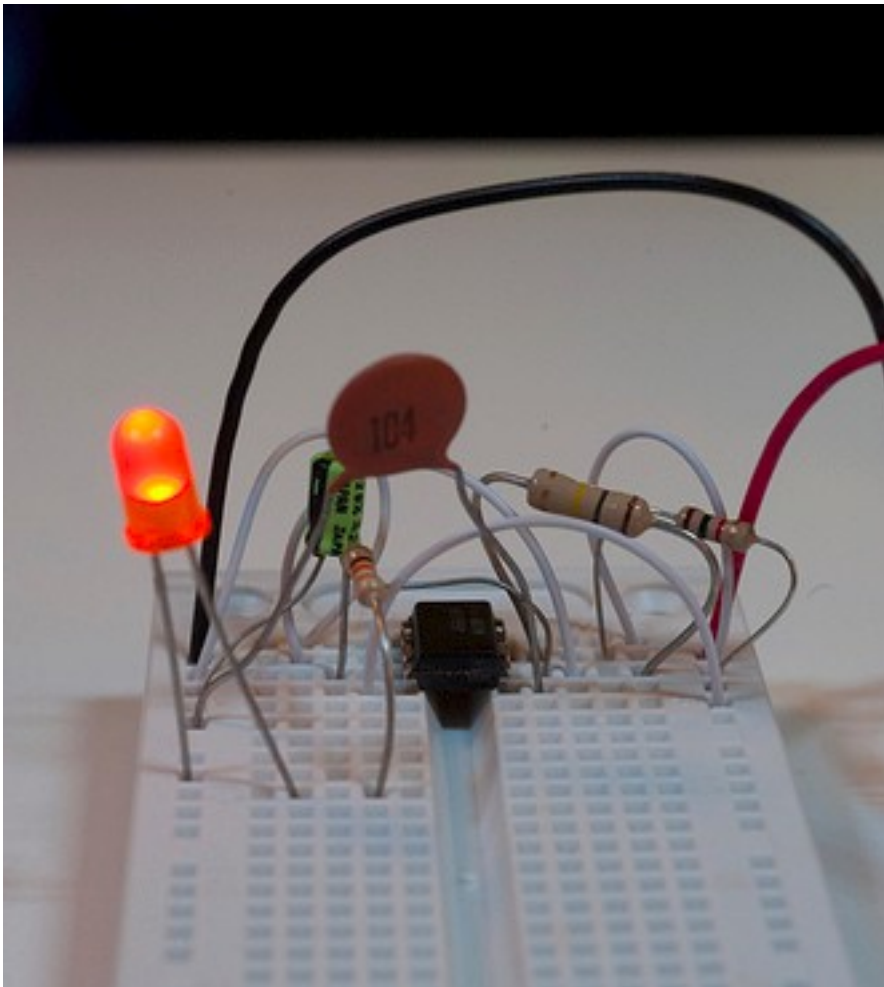

Today we'll be covering:

- Voltage
- Current
- Simple electrical components
- Circuit diagrams
- Simple circuits and designs
- Useful applications

Electricity: Voltage and Current

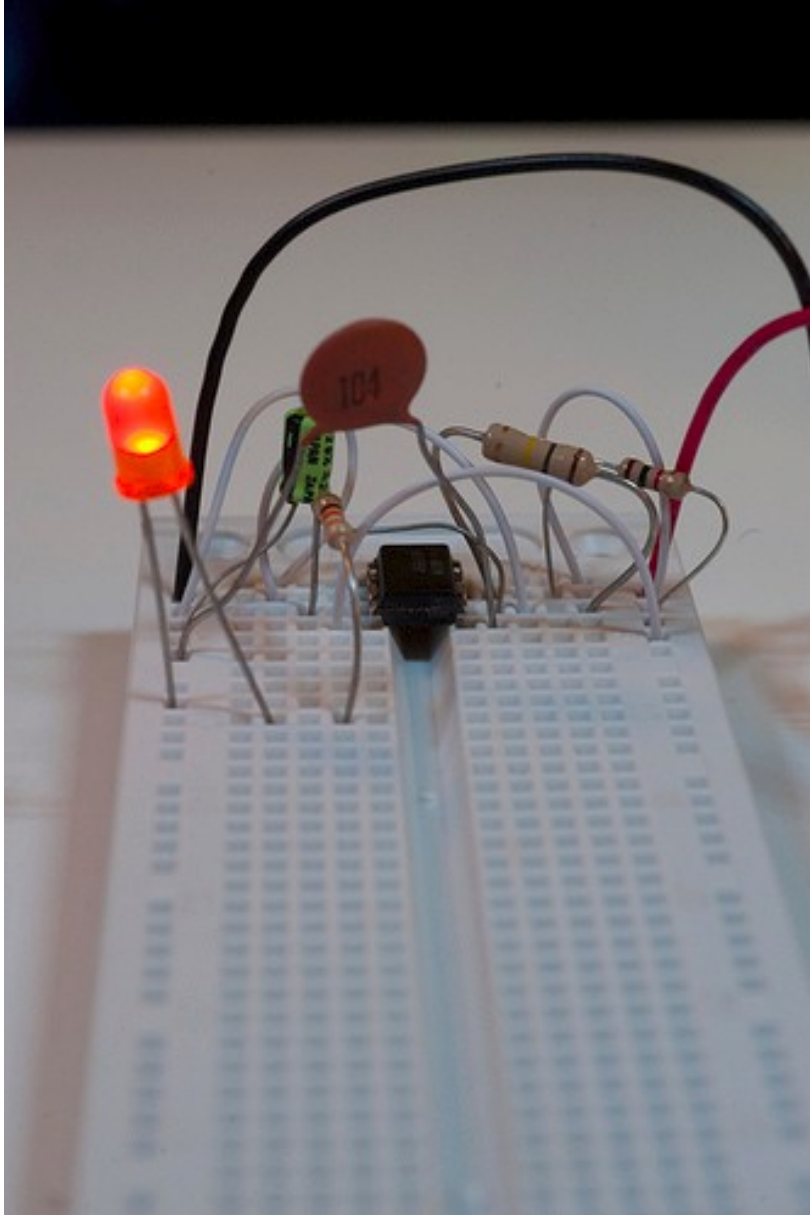

=



Voltage Sources



- Supply a constant voltage
- Current may vary
- Output has units of Volts

Resistors

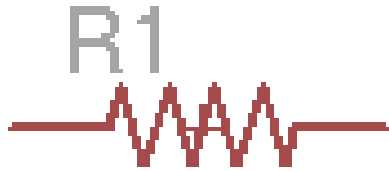

- Has a voltage drop proportional to the current across it
- Used to control current and voltage
- Has units of Ohms
- Ohm's law: $V=I \times R$

Resistor Values

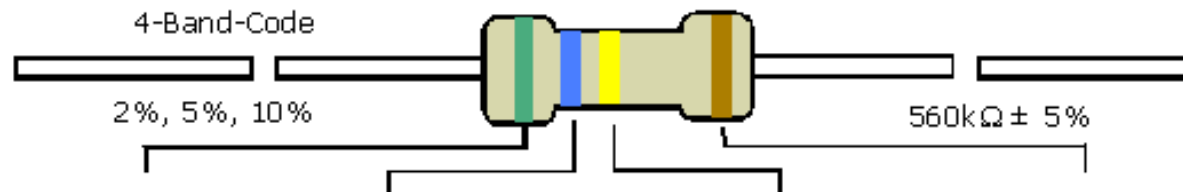

COLOR	1st BAND	2nd BAND	3rd BAND	MULTIPLIER	TOLERANCE
Black	0	0	0	1Ω	
Brown	1	1	1	10Ω	± 1% (F)
Red	2	2	2	100Ω	± 2% (G)
Orange	3	3	3	1KΩ	
Yellow	4	4	4	10KΩ	
Green	5	5	5	100KΩ	±0.5% (D)
Blue	6	6	6	1MΩ	±0.25% (C)
Violet	7	7	7	10MΩ	±0.10% (B)
Grey	8	8	8		±0.05%
White	9	9	9		
Gold				0.1	± 5% (J)
Silver				0.01	± 10% (K)



LEDS

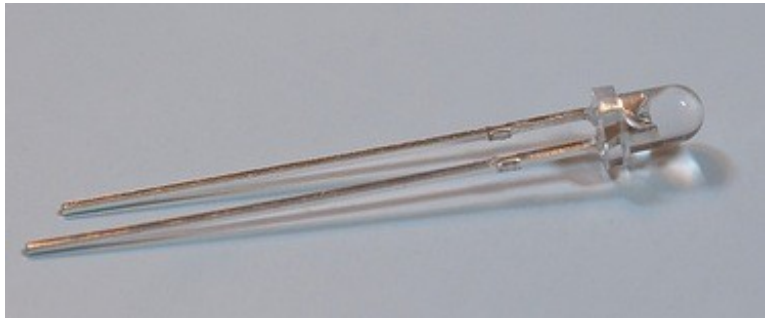

- Light Emitting Diodes
- Have a constant voltage drop
- Light is proportional to current
- Damaged by too much current

What is GND?



Voltage is always measured with respect to some zero. GND defines where zero is in the circuit.

Breadboards

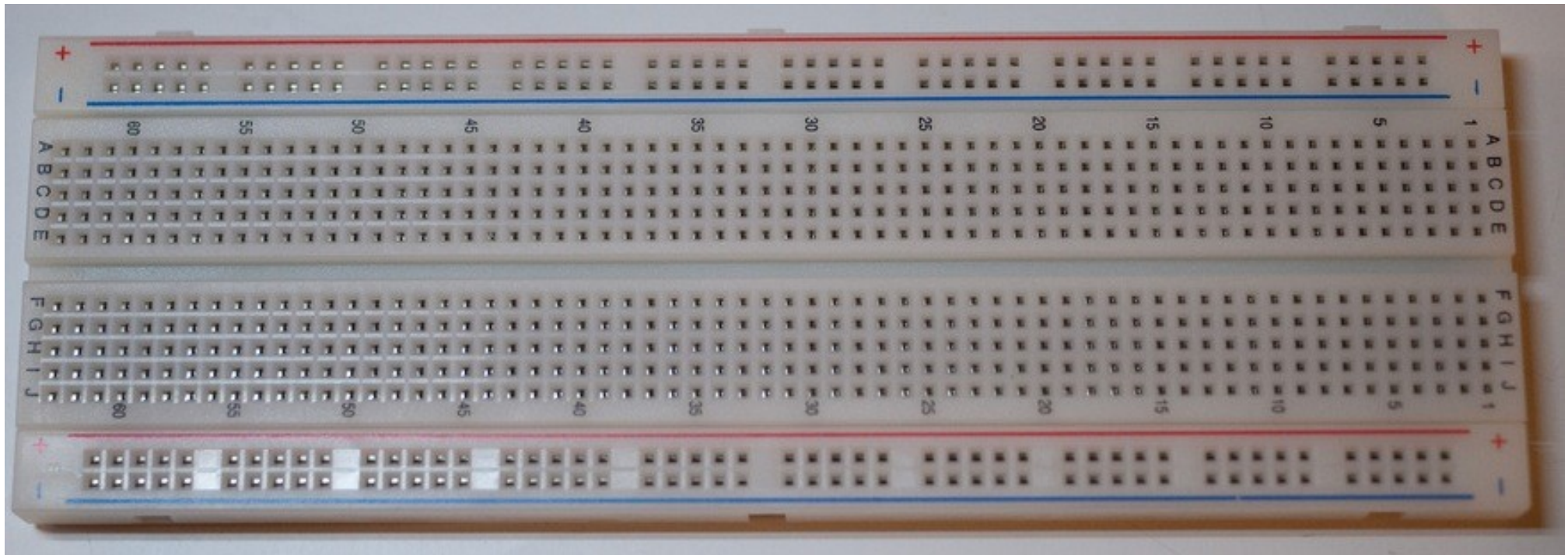

Our first circuit: light an LED

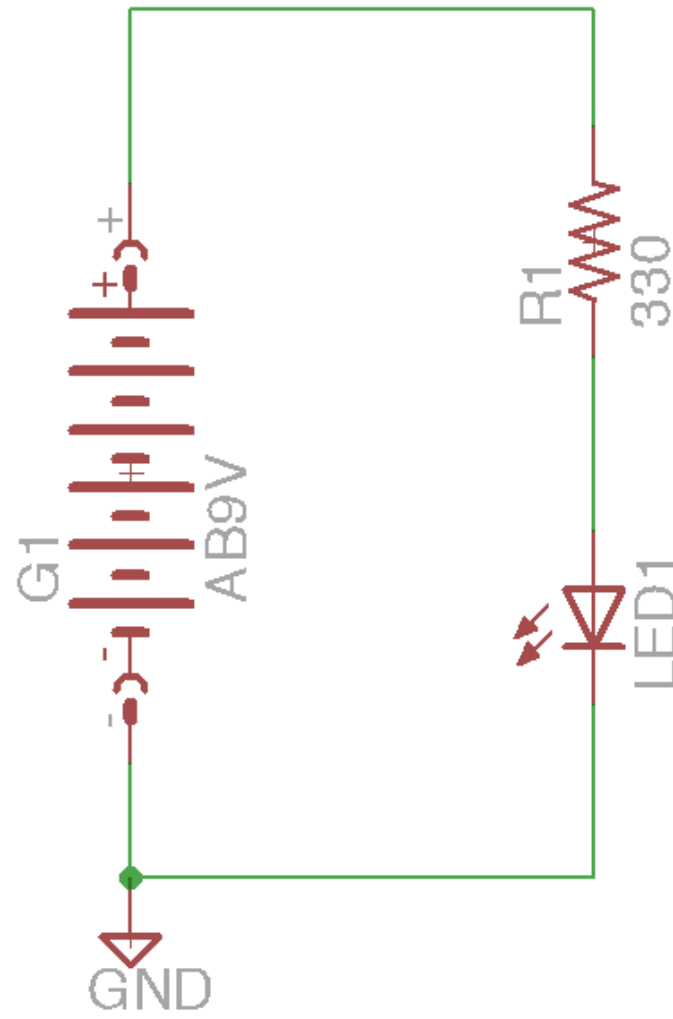

Kirchhoff and his laws

The Voltage Law:

- The sum of the voltage drops around a loop is always zero

The Current Law:

- Current into a wire node is equal to the current out of the node

Your friend, the multimeter



- Voltage: place probes in parallel
- Current: place probes in series

Potentiometers

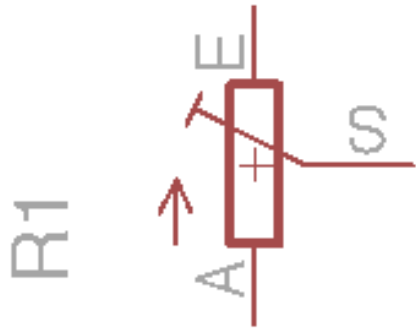

- Constant Resistance between outer leads
- Variable resistance between center lead and either outer lead.

Change the brightness

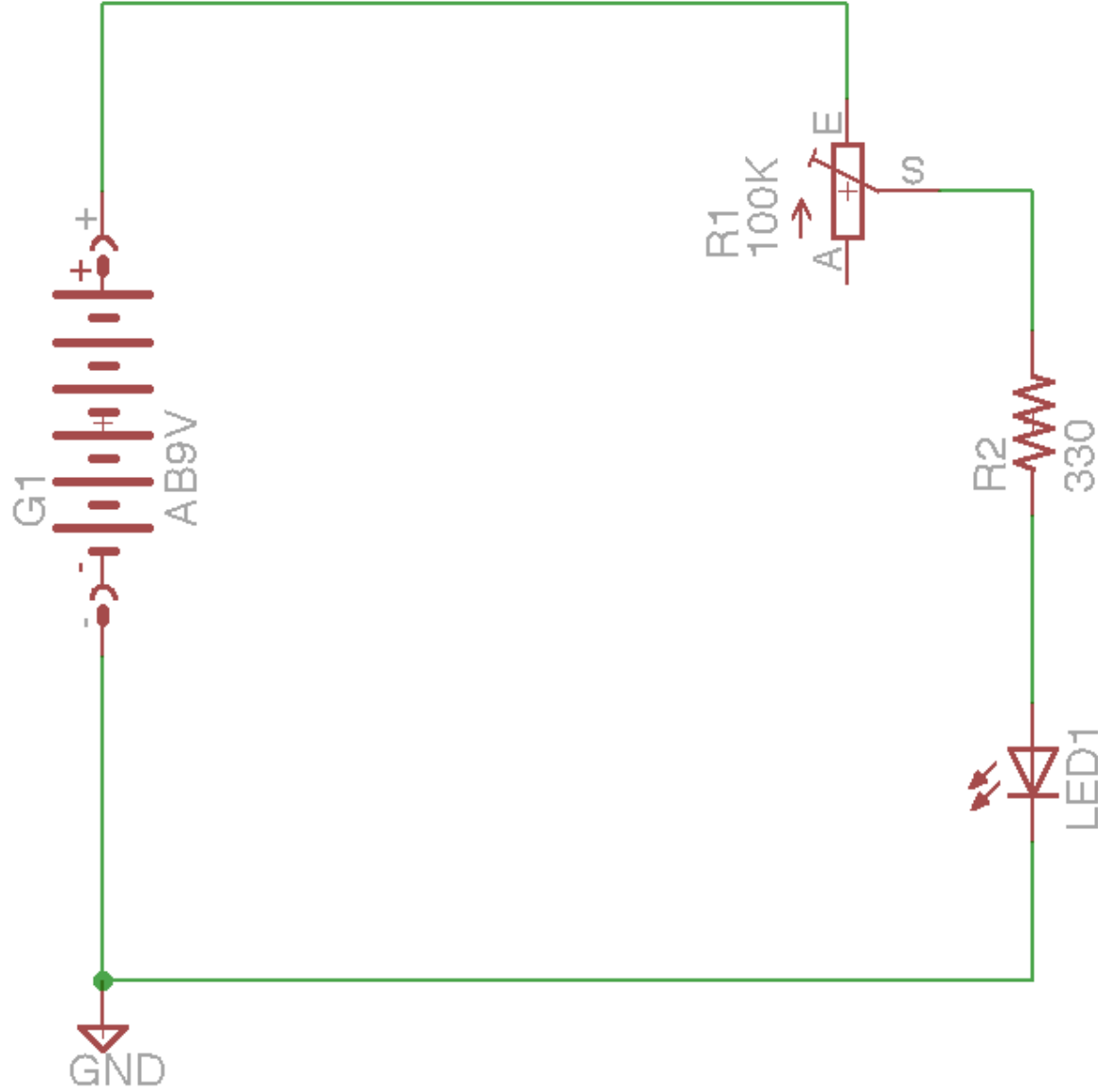

Buttons and Switches

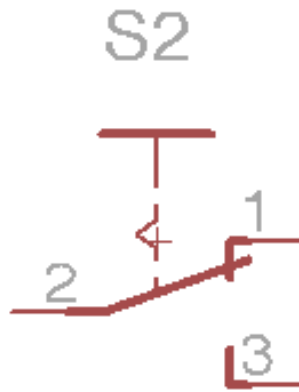

- Single Pole/Double Throw
- These are exactly what you think they are

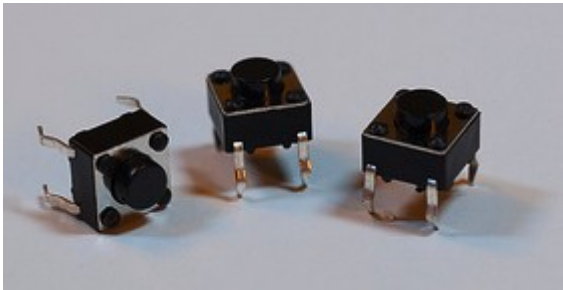

Capacitors

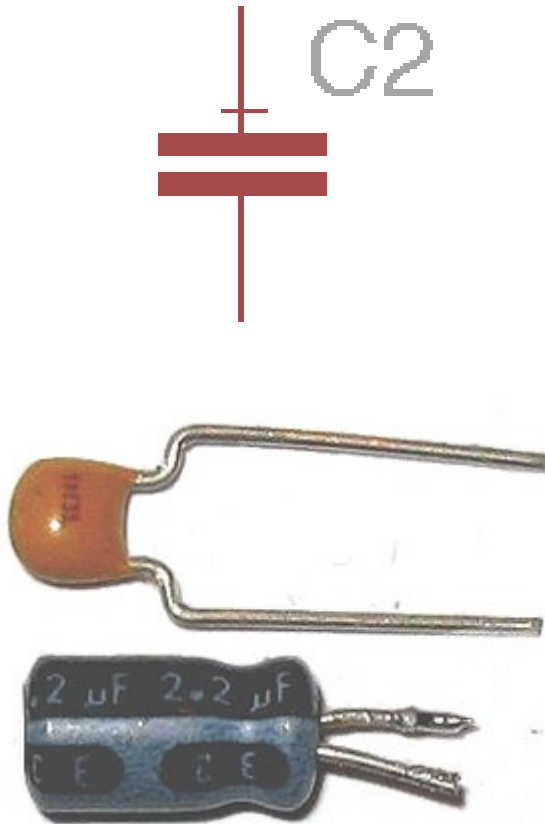

- Store voltage
- Has units of Farads
- Higher capacitance means more power can be stored
- 63% charge time is $R \times C$

Fading the brightness

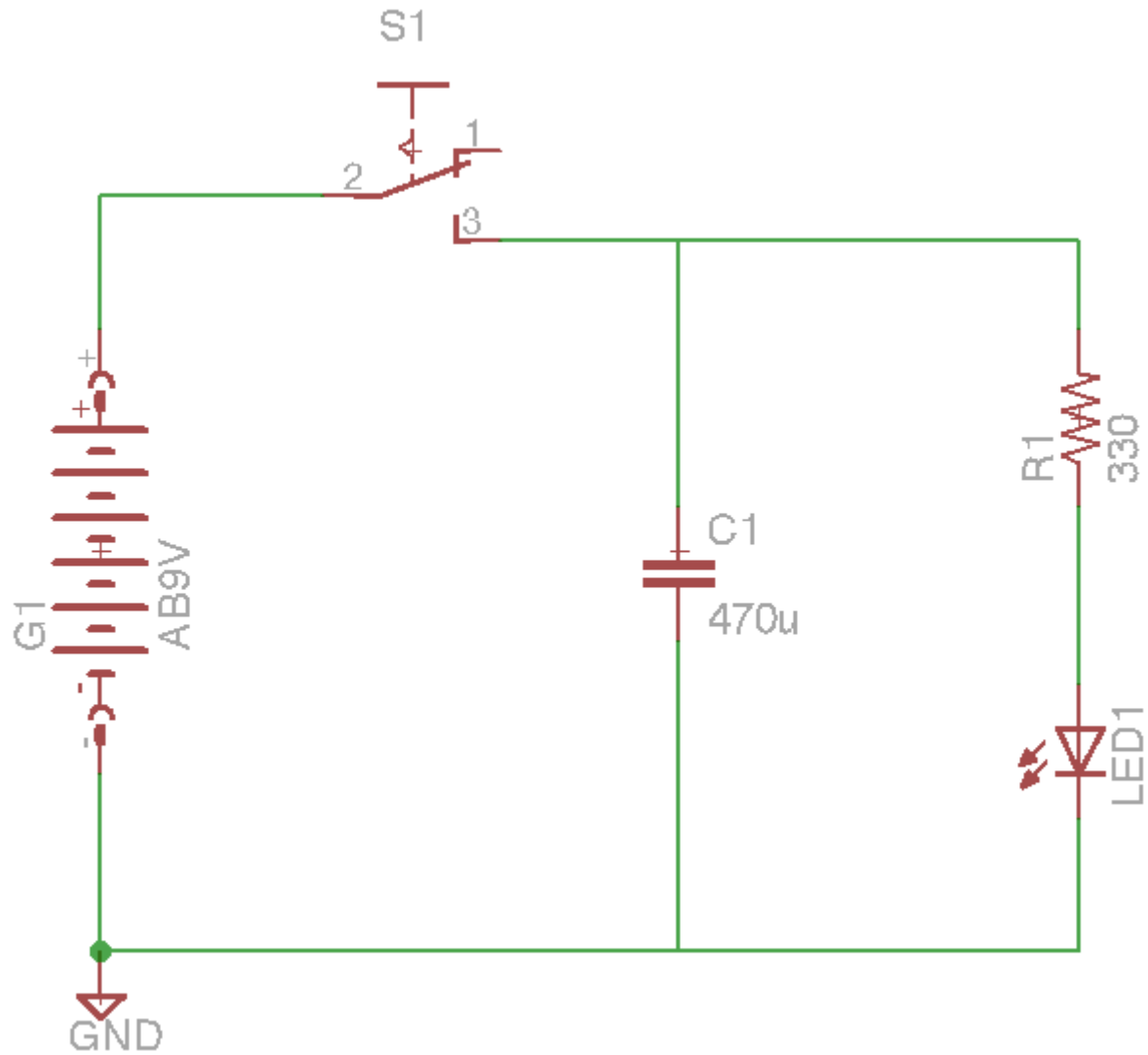

Integrated Circuits (the 555 timer)

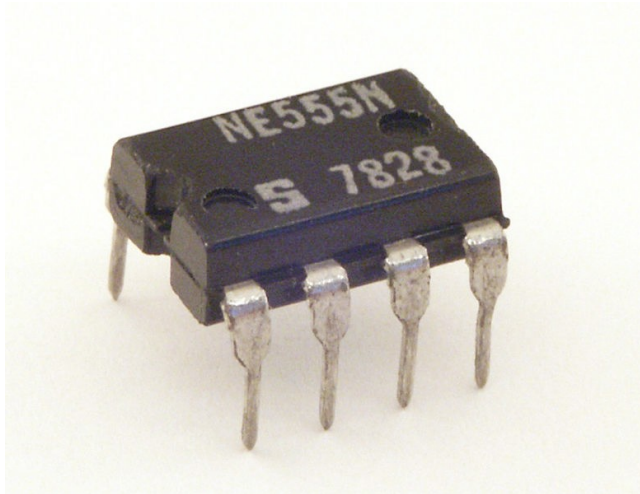
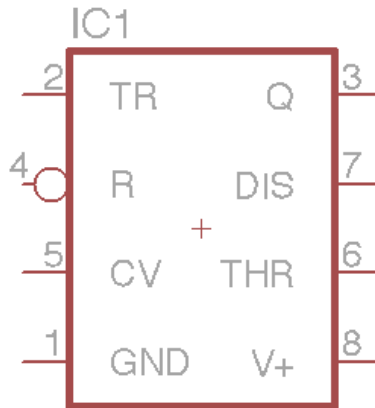

- Adjustable oscillator
- Controlled by connecting resistors and capacitors to input pins
- Choose DIP for breadboard use

Datasheets

- Almost all components have a datasheet
- Will tell you how to use a component
- Example circuits can let you cheat
- Be sure to check:
 - Pinouts
 - Max values

Blinking an LED

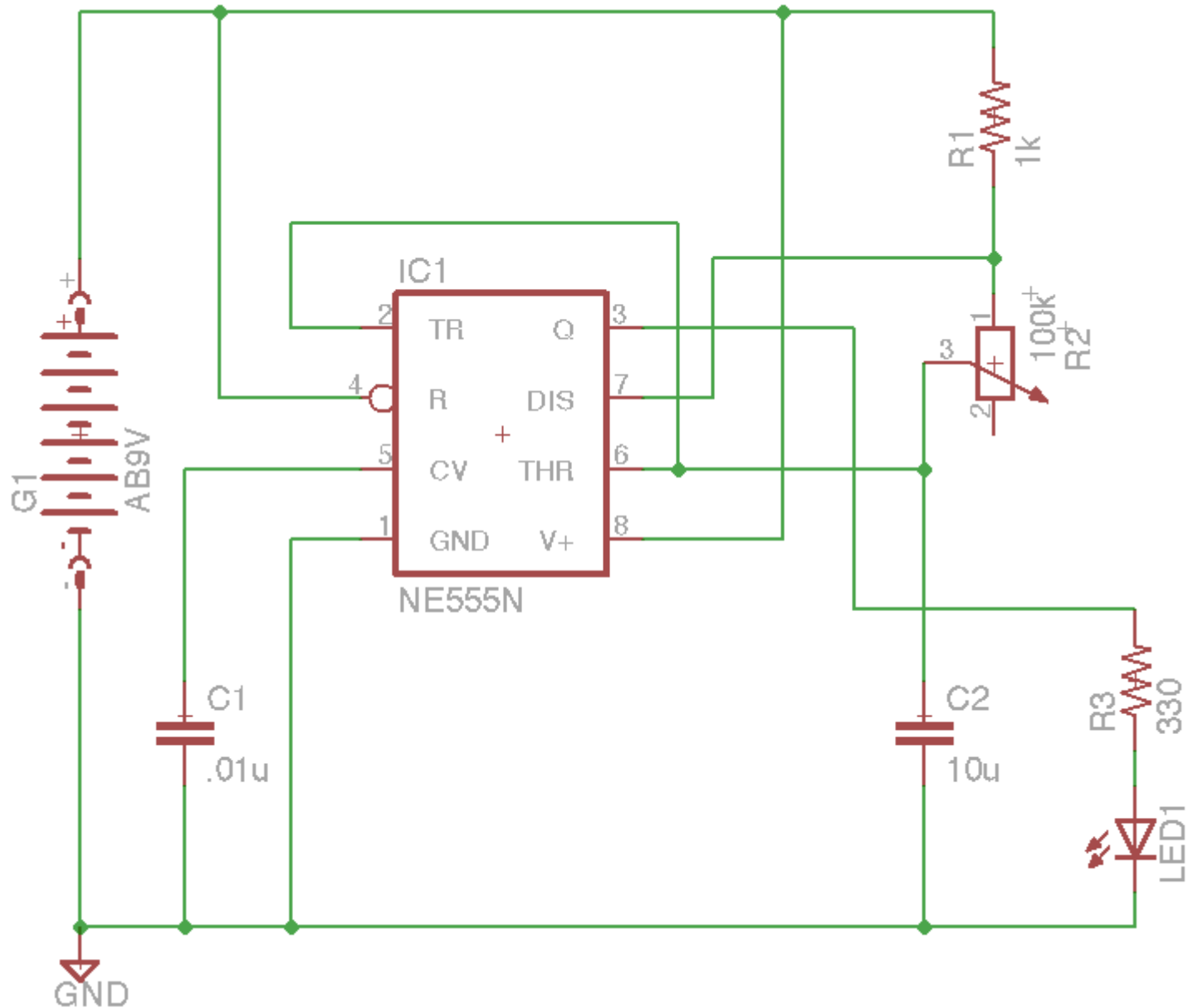

Where do I go next?

- Take apart your toys
- Forrest M. Mims III
- Make magazine
- Make your own things:
 - Analog electronics
 - Digital logic
 - Whatever you can imagine